

The Milling System

Type 75

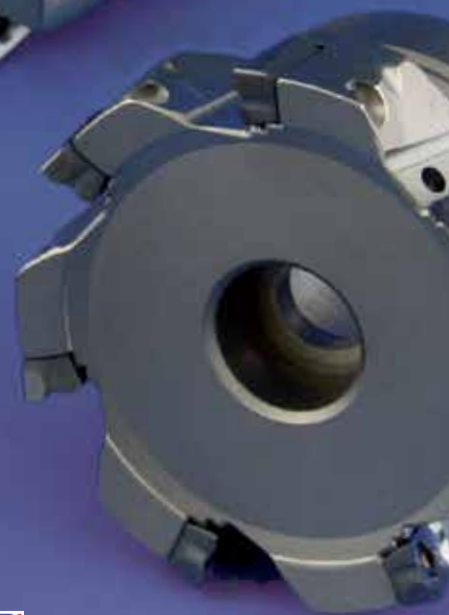

THE TOOL

> New step milling programme ensure a smooth running of the machines, with highest productivity and precision.

CHARACTERISTICS

Multi-functional step-, slot- and contour milling.

> The positive cutting geometry allows a smooth running with lowest vibrations rate.

> Almost step-free milling can be obtained.

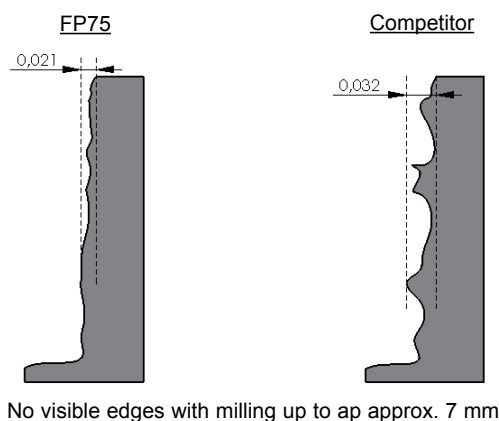

> The different tool versions shank-, screw-in-, shell- and multi-tooth milling cutters allow almost all usual milling operations.



The different available versions are:

- Shell type cutters with normal and close tooth pitch, with diameter range 32-125 mm.
- Shank type milling cutters made to DIN1835-B, normal and close tooth pitch, diameters 20-40 mm
- Shank type milling cutters made to DIN1835-A, long version, diameter 20-32 mm
- Screw-in milling cutters for machining big cavities, diameters 20-40 mm.
- Multi-tooth milling cutters made to DIN1835-B, diameters 20-32 mm and as shell type mill with diameters available from 40-63 mm

> Different numbers of teeth ensure the application in terms of roughing, finishing, big cavities etc.

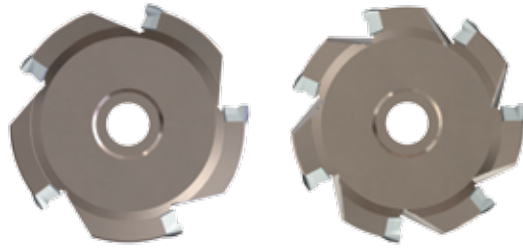

> All tools include internal coolant passages

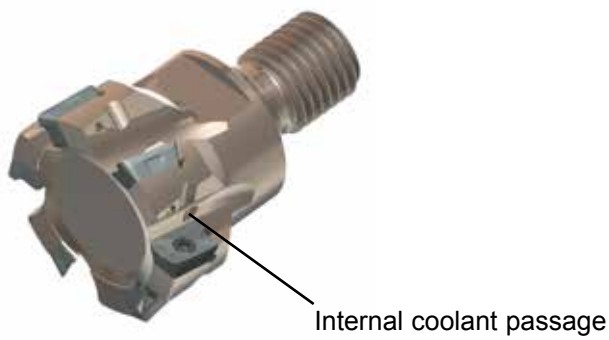

APPLICATION AREAS

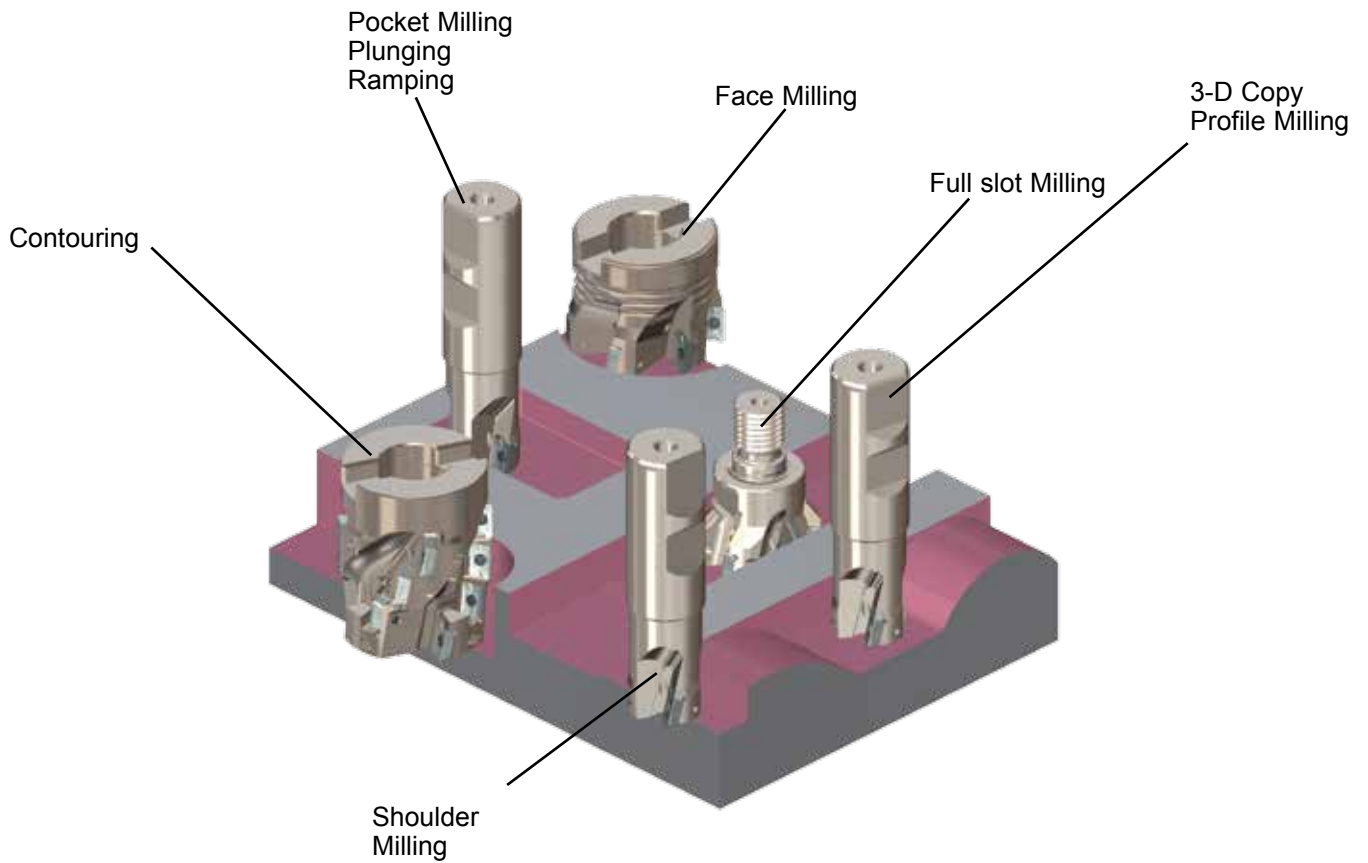

THE INSERT

- > 2-edge step milling insert with a depth of cut (ap) of up to 10 mm, positive geometry.
- > The starting sales programme includes precision sintered as well as completely ground inserts, with different edge radii.



FP75

Precision sintered version

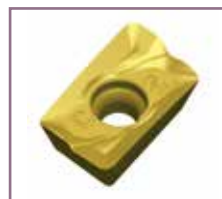

FP76

Completely ground Version

- > Almost all usual materials can be processed, that means from the aluminium machining, difficult materials, over the cast iron machining and the machining of different steels.

Following carbide qualities are offered:

HT45



Code 31 , Iso-Classifizierung P30-35

Very tough fine grain carbide with an AlTiN- Nanocomposit-coating for middle to high cutting speeds with high feed rates. This quality is suitable for dry milling and can also be adopted with cooling. Application areas are roughing and finishing of almost all steels and cast iron qualities such as: structural steel, tool steel, heat-treatable steel as well as unalloyed steel, low alloyed steel, high alloyed steel and also grey cast iron, globular graphite cast iron etc.

HT50®



Code 22 , Iso-Classifizierung P30-35

Very tough fine grain carbide quality with a TiAlN-coating for middle to high cutting speeds and high feed rates. This quality is suitable for dry milling and can also be adopted with cooling. Application areas are roughing and finishing of almost all steels and cast iron materials, e.g. structural steel, tool steel, heat-treatable steel as well as unalloyed steel, low alloyed steel, high alloyed steel and also grey cast iron, globular graphite cast iron etc.

HT32



Code 33 , Iso-Classifizierung M20-M30

Hard wearing and tough finest grain carbide with an AlTiN- Nanocomposit-coating for medium to high cutting speeds and middle feed rates. This quality is equally applicable for dry as well as wet milling. It is especially suited for processing stainless steel, tool steel as well as high alloyed steel.

HT30



Code 29 , Iso-Classifizierung M25-M35

Hard wearing and tough finest grain carbide with an multilayer AlTiN- Nanocomposit-coating for middle cutting speeds and middle feed rates. This quality is suitable for dry milling and can also be adopted with cooling. Application areas are roughing and finishing high grade steel as well as high alloyed materials.

HT20



Code 32 , Iso-Classifizierung K15-K20

Very hard wearing fine grain carbide with an AlTiN- Nanocomposit-coating for middle – high cutting speeds with high feed rates. This quality is suitable for dry milling and can also be adopted with cooling. Application areas are roughing and finishing of cast iron materials, e.g. grey-, tempered-, vermicular-, graphite- and globular graphite cast iron.

KT28**Code 23 , Iso-Classifizierung K15-K20**

Very hard wearing fine grain carbide with a TiAlN-coating for middle to high cutting speeds and high feed rates. This quality is suitable for dry milling and can also be adopted with cooling. Application areas are roughing and finishing of cast iron materials such as: grey-, tempered-, vermicular-, graphite- and globular graphite cast iron.

K15M**Code 8 , Iso-Classifizierung K10**

Very hard wearing fine grain carbide, for high cutting speeds with high feed rates. This quality is suitable for dry milling and can also be adopted with cooling. Application areas are roughing and finishing nonferrous heavy materials and aluminium up to a Si-content of approx. 8%.

XC35**Code 46 , Iso-Classifizierung M20-M30**

Wear resistant and tough finest grain hard metal quality with power nitride coating. On the basis of the experience gained wet machining is preferably to be adopted with this quality; however the dry processing is also possible. XC35 has been especially developed for processing stainless steel, duplex steel and high-alloyed materials, but also for titanium etc.

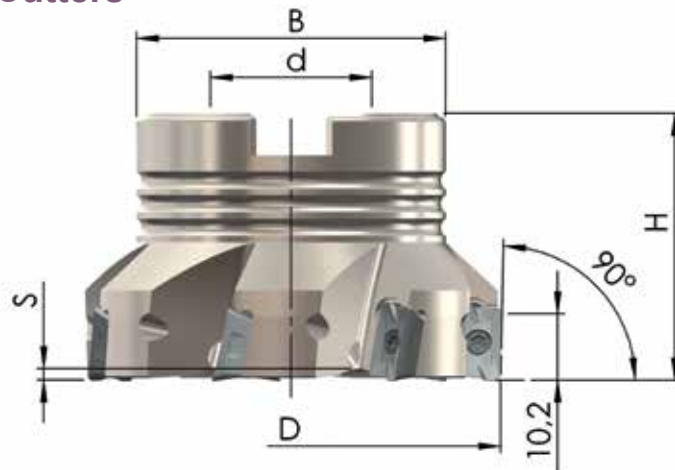
TECHNICAL DATA**Shell Type Milling Cutters**

Order-Nr.	D	H	d	B	S	Z	MS
90PP-040-75-16-4	40	40	16	32	2,0	4	MS-8x25-912
90PP-040-75-22-4	40	40	22	38	2,0	4	MS-10x25-912
90PP-050-75-5	50	40	22	46	2,0	5	MS-10x25-912
90PP-063-75-5	63	40	22	46	2,0	5	MS-10x25-912
90PP-080-75-7	80	50	27	54	2,0	7	MS-12x35-912
90PP-100-75-9	100	50	32	64	2,0	9	MS-16x30-912
90PP-125-75-13	125	50	40	90	2,0	13	MS-20x45-7991
Close teeth pitch							
90PP-032-75-16-5	32	35	16	29	2,2	5	DS12
90PP-040-75-16-5	40	40	16	32	2,0	5	MS-8x25-912
90PP-040-75-22-5	40	40	22	38	2,0	5	MS-10x25-912
90PP-050-75-6	50	40	22	46	2,0	6	MS-10x25-912
90PP-063-75-7	63	40	22	46	2,0	7	MS-10x25-912
90PP-080-75-9	80	50	27	54	2,0	9	MS-12x35-912
90PP-100-75-12	100	50	32	64	2,0	12	MS-16x30-912

Shank Type Milling Cutters made to DIN 1835-B (Weldon)

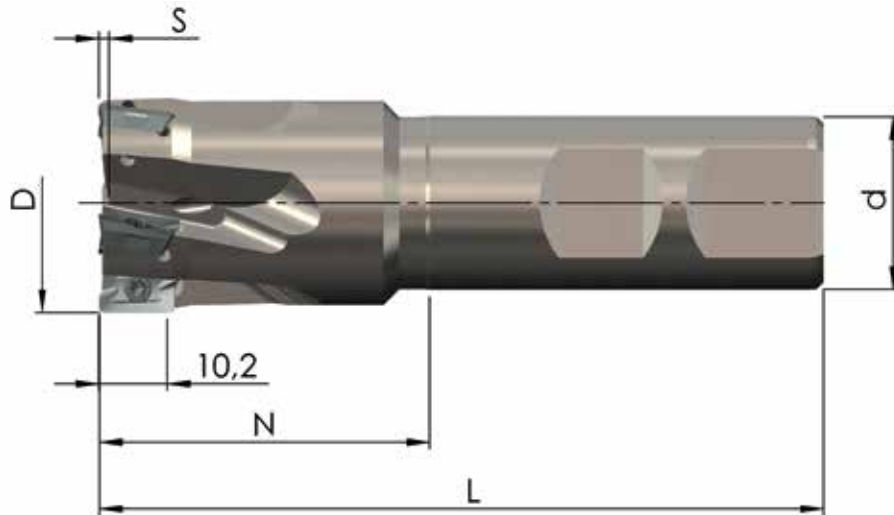

Order-Nr.	D	L	d	N	S	Z
90PP-20-32-75-2	20	82,4	20	32	2,0	2
90PP-20-50-75-2	20	100,4	20	50	2,0	2
90PP-22-33-75-3	22	83,3	20	33	2,0	3
90PP-25-38-75-3	25	95,2	25	38	2,0	3
90PP-25-60-75-3	25	117,2	25	60	2,0	3
90PP-28-42-75-4	28	98,4	25	42	2,0	4
90PP-30-45-75-4	30	101,3	25	45	2,0	4
90PP-32-48-75-3	32	104,3	25	48	2,0	3
90PP-32-60-75-3	32	116,3	25	60	2,0	3
90PP-36-48-75-5	36	104,2	25	48	2,0	5
90PP-40-48-75-5	40	104,1	25	48	2,0	5
Close teeth pitch						
90PP-20-30-75-3	20	81,8	20	30	2,0	3
90PP-25-38-75-4	25	95,2	25	38	2,0	4
90PP-32-48-75-5	32	104,3	25	48	2,0	5

Shank Type Milling Cutters made to DIN 1836 (cylindrical)

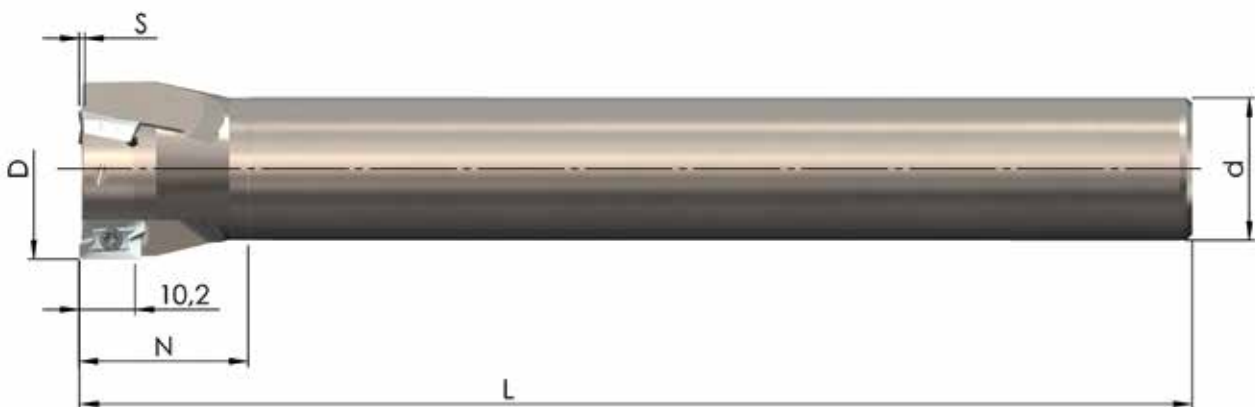

Order-Nr.	D	L	d	N	S	Z
90PP-20-75-2-150	20	150	18	30	2,0	2
90PP-25-75-2-170	25	170	20	32	2,0	2
90PP-32-75-3-195	32	195	25	30	2,0	3

Screw-In Cutters

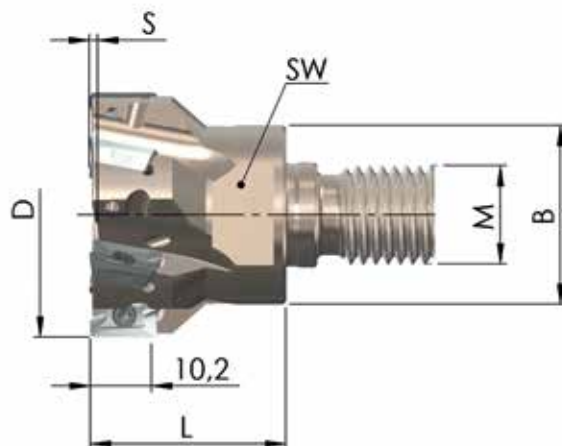

Order-Nr.	D	L	M	B	SW	S	Z
ESF-20-27-M10-75-2	20	27	M10	18,0	SW16	2,0	2
ESF-25-32-M12-75-3	25	32	M12	21,0	SW18	2,0	3
ESF-32-32-M16-75-3	32	32	M16	29,0	SW24	2,0	3
ESF-35-32-M16-75-4	35	32	M16	29,0	SW24	2,0	4
ESF-40-32-M16-75-4	40	32	M16	29,0	SW24	2,0	4
Close teeth pitch							
ESF-20-27-M10-75-3	20	27	M10	18,0	SW16	2,0	3
ESF-25-32-M12-75-4	25	32	M12	21,0	SW18	2,0	4
ESF-32-32-M16-75-5	32	32	M16	29,0	SW24	2,0	5
ESF-35-32-M16-75-5	35	32	M16	29,0	SW24	2,0	5
ESF-40-32-M16-75-6	40	32	M16	29,0	SW24	2,0	6

Multi-Tooth Milling Cutters

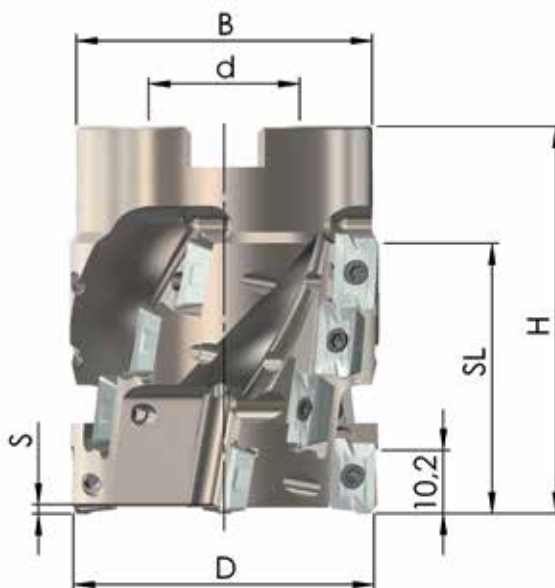



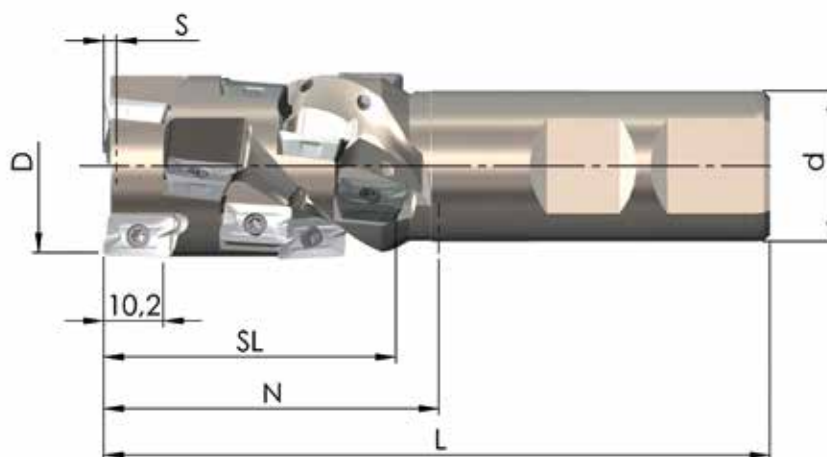















































Order-Nr.	D	SL	H	d	B	S	Z _{eff.}	ZZ	MS
VZF 40-35-75-3 KD16	40	35	54	16	36	2,0	3	12	MS-8x50-912
VZF 50-35-75-4 KD22	50	35	60	22	46	2,0	4	16	MS-10x50-912
VZF 63-44-75-5 KD27	63	44	69	27	55	2,0	5	25	MS-12x60-912







Order-Nr.	D	SL	N	L	d	S	Z _{eff.}	ZZ
VZF 20-18-20-75-2	20	20	50	100	20	2,0	2	4
VZF 25-27-25-75-2	25	27	54	110	25	2,0	2	6
VZF 28-27-25-75-2	28	27	54	110	25	2,0	2	6
VZF 32-44-25-75-3	32	44	54	110	25	2,0	3	12
VZF 32-44-32-75-3	32	44	60	120	32	2,0	3	12

Inserts

		HT45 (code 31)	HT50 (code 22)	HT32 (code 33)	HT30 (code 29)	HT20 (code 32)	KT28 (code 23)	K15M (code 8)	XC35 (code 46)
									
									
									
									
									
									
									
									
									
									
	VPE	20	20	20	20	20	20	20	20

Spare Parts

	SS2,5-7	tightening torque 1,2 - 1,3 Nm	Fixing screw
	SS2,5-6	tightening torque 1,2 - 1,3 Nm	Fixing screw for tools with diam. 20
	T08+	Screw driver	
	100g	Heavy duty grease	

PARAMETERS STEP MILLING

Material	Hardness	Quality	Depth of cut a_e [mm]	Cutting speed V_c [m/min.]	
P	Structural steel, Unalloyed steel	HT45 HT50	-0,25D	250 (200-350)	
			-0,5D		
			-0,75D		
			>0,75D-1D		
	Tool steel, Heat-treatable steel, Alloyed steel	180-350 HB	HT45 HT50 (HT32) (XC35)	-0,25D	220 (160-280)
				-0,5D	
				-0,75D	
				>0,75D-1D	
M	Stainless-steel, High grade steel, High alloyed steel,	HT30 HT32 XC35 (HT45) (HT50))	-0,25D	240 (140-300)	
			-0,5D		
			-0,75D		
			>0,75D-1D		
S	Heat-resistant super alloys Titan alloys	XC35 HT32 (HT30)	-0,25D	60 (40-200)	
			-0,5D		
			-0,75D		
			>0,75D-1D		
H	Tempered steel	HT20 KT28	-0,25D	80 (50-120)	
			-0,5D		
			-0,75D		
			>0,75D-1D		
K	Grey cast iron	HT20 KT28	-0,25D	250 (180-350)	
			-0,5D		
			-0,75D		
			>0,75D-1D		
	Globular graphite cast iron	<350 N/mm ²	HT20 KT28 (HT45) (HT50)	-0,25D	200 (130-280)
				-0,5D	
				-0,75D	
				>0,75D-1D	
N	Aluminium Non-ferrous metals	K15M	-0,25D	500 (500-1000)	
			-0,5D		
			-0,75D		
			>0,75D-1D		

The above mentioned data are standard values.

Up and down corrections are admitted depending on the machine type, tool and holding fixture.

Feed rate per tooth f_z [mm]		
$\varnothing 20-28$	$\varnothing 30-50$	$\varnothing 63-125$
0,22 (0,18-0,30)	0,24 (0,18-0,30)	0,25 (0,18-0,30)
0,20 (0,18-0,28)	0,21 (0,18-0,28)	0,23 (0,18-0,28)
0,15 (0,10-0,25)	0,17 (0,10-0,25)	0,18 (0,10 -0,25)
0,12 (0,10-0,25)	0,14 (0,10-0,25)	0,15 (0,10-0,25)
0,22 (0,18-0,30)	0,23 (0,10-0,30)	0,25 (0,10-0,30)
0,20 (0,18-0,28)	0,21 (0,10-0,28)	0,23 (0,10-0,28)
0,15 (0,10-0,25)	0,18 (0,10-0,25)	0,18 (0,10-0,25)
0,12 (0,10-0,25)	0,13 (0,10-0,25)	0,15 (0,10-0,25)
0,18 (0,10-0,30)	0,19 (0,10-0,30)	0,20 (0,10-0,30)
0,12 (0,05-0,25)	0,13 (0,05-0,25)	0,14 (0,05-0,25)
0,10 (0,05-0,25)	0,13 (0,05-0,25)	0,12 (0,05-0,25)
0,10 (0,05-0,25)	0,11 (0,10-0,25)	0,13 (0,10-0,25)
0,18 (0,10-0,30)	0,19 (0,10-0,30)	0,20 (0,10-0,30)
0,12 (0,05-0,25)	0,13 (0,05-0,25)	0,14 (0,05-0,25)
0,10 (0,05-0,25)	0,13 (0,05-0,25)	0,12 (0,05-0,25)
0,08 (0,05-0,25)	0,09 (0,10-0,25)	0,10 (0,10-0,25)
0,10 (0,08-0,25)	0,10 (0,08-0,25)	0,10 (0,08-0,25)
0,07 (0,05-0,25)	0,07 (0,05-0,25)	0,07 (0,05-0,25)
0,06 (0,05-0,25)	0,06 (0,05-0,25)	0,06 (0,05-0,25)
0,05 (0,03-0,15)	0,05 (0,03-0,15)	0,05 (0,03-0,15)
0,27 (0,20-0,35)	0,29 (0,20-0,35)	0,30 (0,20-0,35)
0,26 (0,20-0,35)	0,27 (0,20-0,35)	0,28 (0,20-0,35)
0,21 (0,20-0,35)	0,22 (0,20-0,35)	0,23 (0,20-0,35)
0,19 (0,15-0,30)	0,20 (0,15-0,30)	0,20 (0,15-0,30)
0,27 (0,20-0,35)	0,29 (0,20-0,35)	0,30 (0,20-0,35)
0,26 (0,20-0,35)	0,27 (0,20-0,35)	0,28 (0,20-0,35)
0,21 (0,20-0,35)	0,22 (0,20-0,35)	0,23 (0,20-0,35)
0,19 (0,15-0,30)	0,20 (0,15-0,30)	0,20 (0,15-0,30)
0,42 (0,20-0,50)	0,43 (0,20-0,50)	0,45 (0,20-0,50)
0,37 (0,20-0,50)	0,39 (0,20-0,50)	0,40 (0,20-0,50)
0,32 (0,20-0,50)	0,34 (0,20-0,50)	0,35 (0,20-0,50)
0,27 (0,20-0,40)	0,29 (0,20-0,40)	0,30 (0,20-0,40)

PARAMETERS PROFILE MILLING AND CIRCULAR MILLING

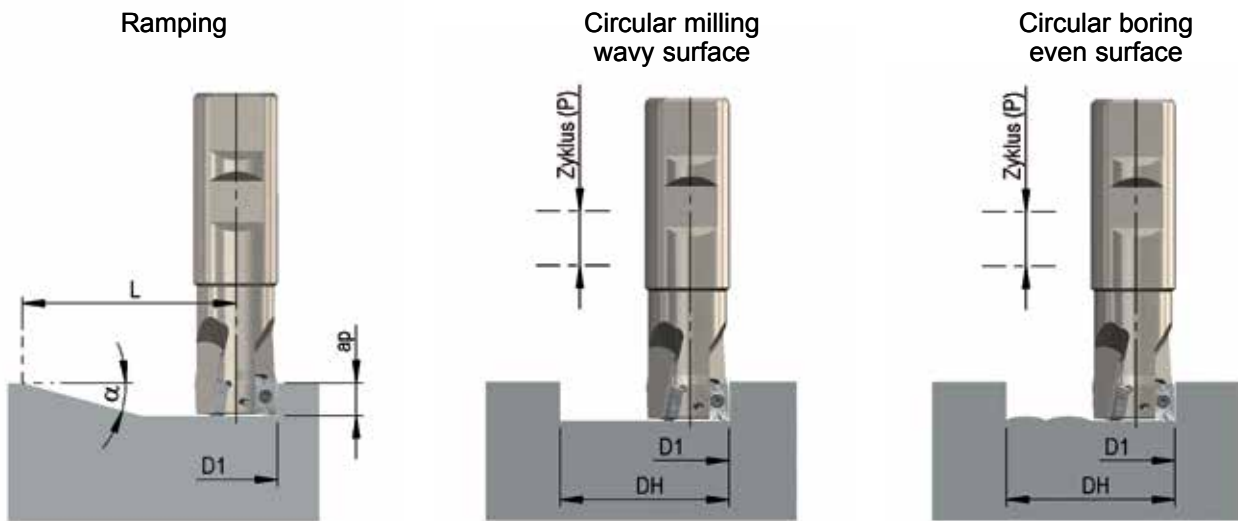

D1	Ramping Angle		Circular boring (flat surface)				Circular milling (wavy surface)	
	Anlge of lead max. α (°)	Processing distance min. L (mm)	Diam. max. DH (mm)	Depth of cut max. cycle P (mm)	Diam. min. DH (mm)	Depth of cut max. cycle P (mm)	Diam. min. DH (mm)	Depth of cut max. cycle P (mm)
20	7,9	13	39,2	4,6	38	4,3	33,5	3,3
22	6,8	15	43,2	4,4	42	4,2	37,5	3,2
25	5,7	18	49,2	4,2	48	4,0	43,5	3,2
28	4,9	21	55,2	4,1	54	3,9	49,5	3,2
30	4,5	23	59,2	4,0	58	3,8	53,5	3,2
32	4,1	25	63,2	3,9	62	3,8	57,5	3,2
35	3,7	28	69,2	3,8	68	3,7	63,5	3,2
36	3,6	29	71,2	3,8	70	3,7	65,5	3,2
40	3,1	33	79,2	3,7	78	3,6	73,5	3,2
50	2,4	43	99,2	3,6	98	3,5	93,5	3,2
63	1,8	56	125,2	3,5	124	3,4	119,5	3,2
80	1,4	73	159,2	3,4	158	3,4	153,5	3,2
100	1,1	93	199,2	3,4	198	3,3	193,5	3,2
125	0,9	118	249,2	3,3	248	3,3	243,5	3,2

Formula for calculating the max. angle of immersion:

$$\tan \alpha = \frac{s}{(D-7)}$$

s = Variable (see above)
7 = Insert's width
D = Tool diam.

Jongen Werkzeugtechnik GmbH

Siemensring 11 · D-47877 Willich · Germany
Phone: +49 2154 9285 2900 · Fax: +49 2154 9285 9 2900
www.jongen.de · email: info@jongen.de